



INSTALLATION MANUAL

WARNING: At least two people are required for installation. Please read and review all instructions carefully prior to installation. Failure to follow directions may lead to serious damage to the canopy and property, as well as injury to yourself. Damage that is caused to the product via a failure to properly follow installation directions is not covered by the original manufacturer's warranty. The manufacturer is not responsible for bodily harm or property damaged caused by a failure to properly follow the directions, or by the inappropriate use of tools (both those that are provided and those that are not). If at any point you require further assistance, please do not hesitate to contact us.

PARTS LIST FOR ONE (1) CANOPY SECTION

Cable Support Parts

4 x Eye Lag Screw (A)

Eye Screws are for wood only. Eye Bolts Sold Separately

1 x Steel Cable (B)

1 x Turnbuckle (C) and Anti-Seize lubricant pack

2 x Safety Clamps (D)

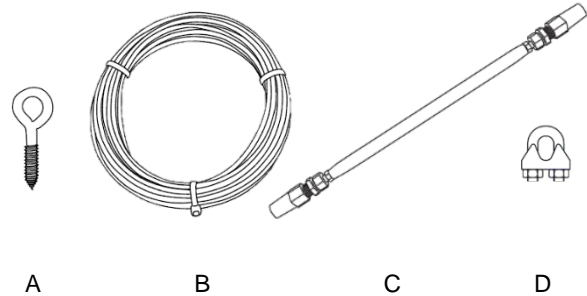

Canopy Parts (Item Quantities Vary Depending on Size Ordered)

Aluminum Profile (E)

End Caps (2 Per Aluminum Profile) (F)

Clip and Base for the First and Last Profiles (anchor the canopy), 2 per canopy (G)

Wheeled Clip and Base (ride the cable), 2 per profile (H)

Limit Tape (I)

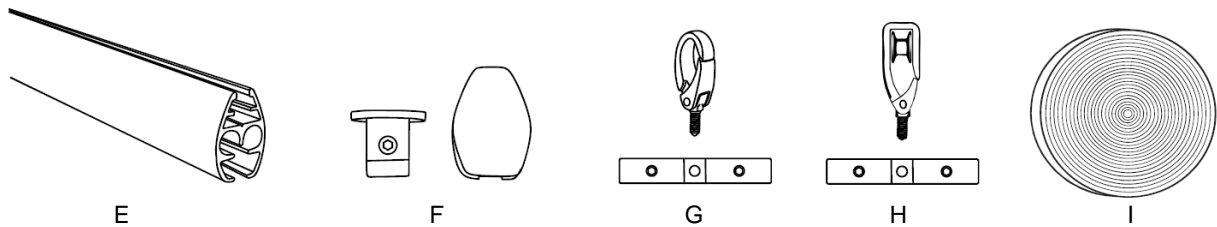

Tools Needed (Not Provided): Cable Cutter, Screwdriver, Adjustable Wrench x 2, Locking Pliers x 2, Drill, Level, Measure Tape.

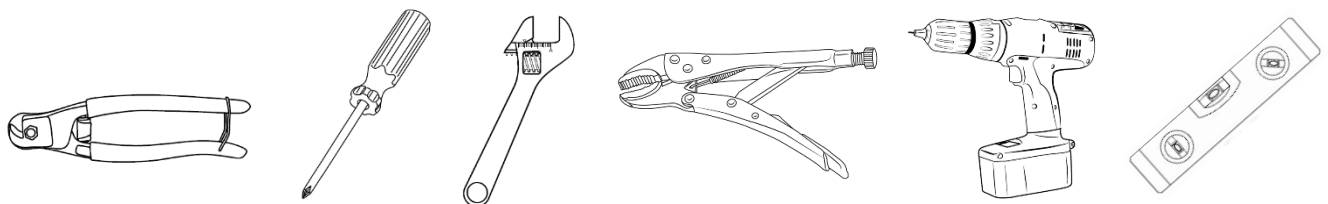

You may require additional hardware or materials for non-wood structures and certain installations.

PART 1. Eyelet Installation

WARNING: There is a great deal of tension on the cables so make sure that your structure is strong enough to provide the appropriate level of support for the cables and canopies. If you are not sure please contact us for guidance or referral to engineering services.

If you plan to attach your cable to a wall or building you must first install a ledger to the building and secure it to multiple studs using appropriate anchors (not provided). The cable eyelets should attach to the ledger and not directly to the building. Infinity Canopy, Inc. is not responsible for any damage caused to the canopy, person or property by improperly installing the included materials. If you are not sure or unable to install the canopy please contact us for referral to a professional installer.

1. Hold one of the supplied profiles against the structure at the desired height then center and level it. (Fig.1).

Make sure to leave at least 1" gap between the canopies and 1" between the canopy and any structure if installing inside a frame.

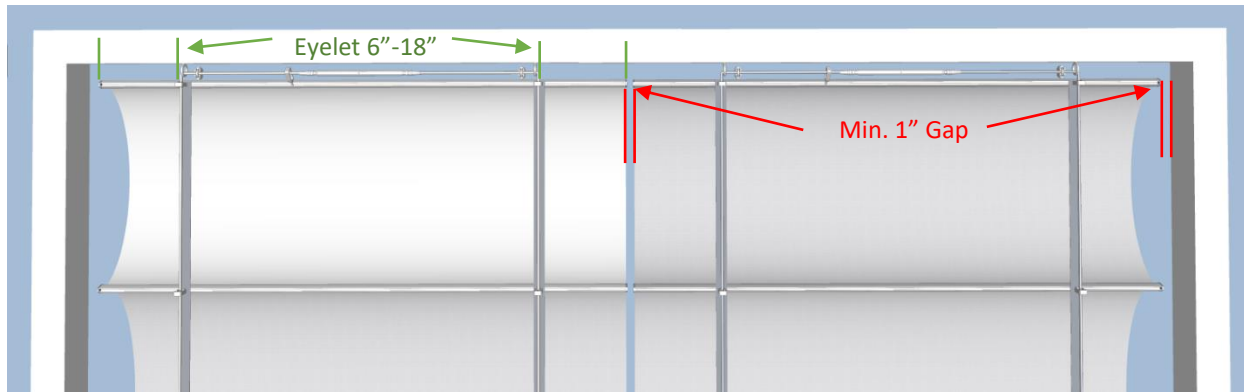

2. Mark the desired locations of the eyelets on the structure and the profile. Make sure that they are within 6 to 18 inches from either end of the profile based on this chart.

Canopy Width	5' or less	>5 to 8'	>8 to 12'
Cable Inset	6"	12"	18"

3. Use the marked profile to find and mark the location of the eyelets on the opposing structure. Make sure that all points are at the same level and parallel.

4. Pre-drill a pilot hole and install the Eye Screw/ Eye Bolt to the marked areas of your structure. Note: For Eye Bolt you need to make the hole through and through.

5. With the eyelets installed proceed to cable and turnbuckle installation.

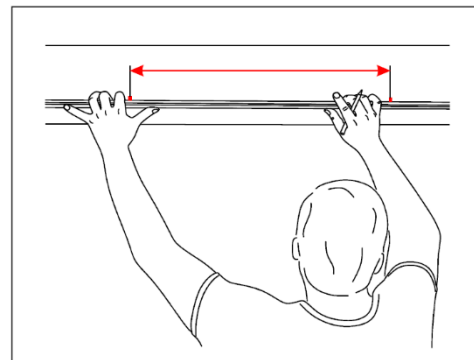

PART 2. Cable – Turnbuckle Installation

The turnbuckle connects to the cable ends together, removes the sag and tensions the cables.

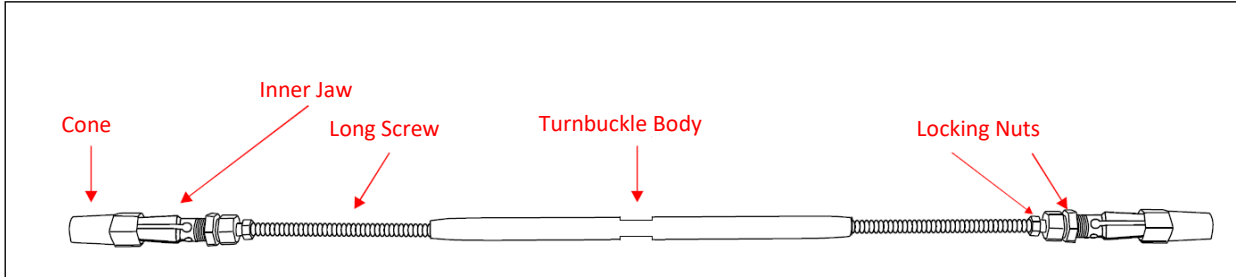

Note: If your turnbuckle is different than shown on this page please refer to the last page of this manual.

1. Open the turnbuckle's long screws without completely removing them.
2. Open the cones on each end and remove the inner jaws. Slightly spread the jaws from the open end.

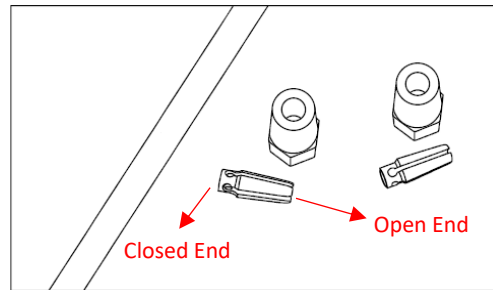
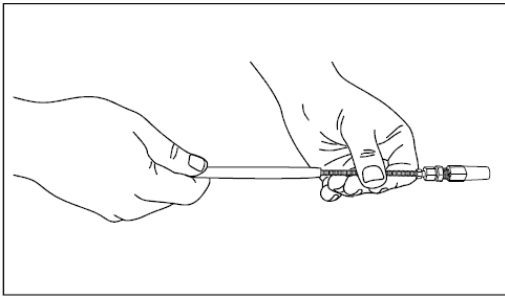

3. Insert one cone into one end of the cable.

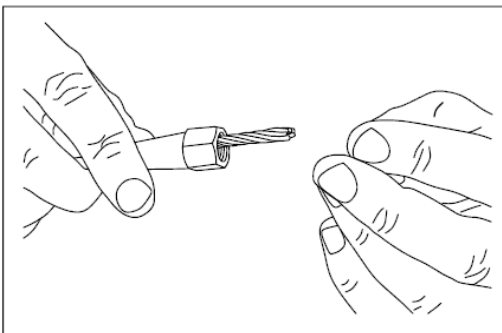

4. Slightly spread the flaps of the jaw and insert the cable into the jaw from the open end making sure that the cable protrudes 3/16 inch (5mm) from the closed end of the jaw.

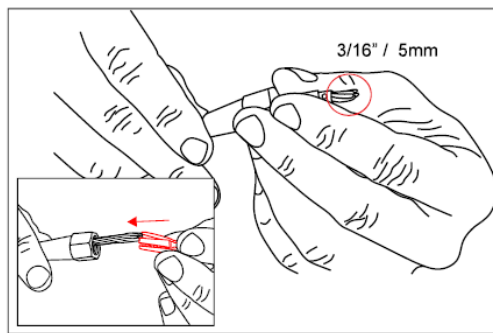

5. Screw the cone to the long screw and tighten it firmly using two wrenches by turning the cone while holding the long.

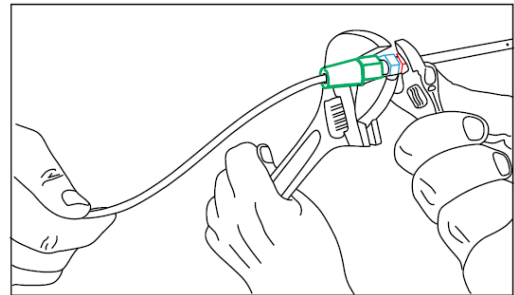
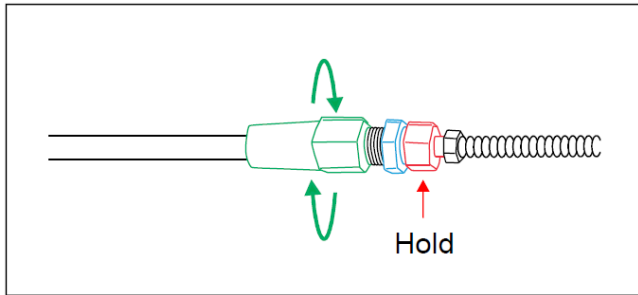

6. Once the cone is tightened as much as possible turn the middle nut towards the cone to lock it in place.

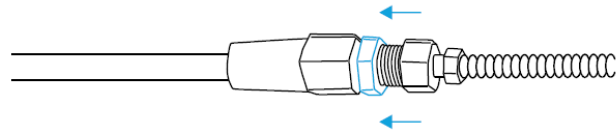

7. Once you have attached one end of the cable to the turnbuckle, insert the open end of the cable into the eye on the stationary side, so the turnbuckle is placed between the two eyes on that side then thread the cable into the remaining eyes and bring the cable to the other end of the turnbuckle.

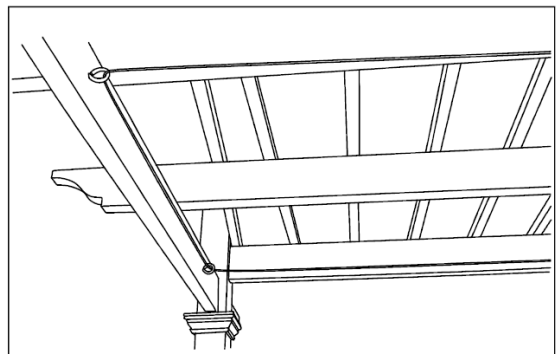
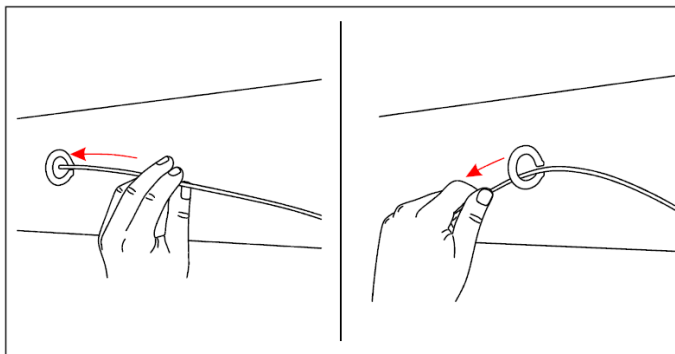

8. Hold the turnbuckle and bring the free end of the cable and the turnbuckle together tightly (Fig.8).

9. If the cable is too long cut the excess cable by marking the desired cut location, plus one inch (Fig.9-10).

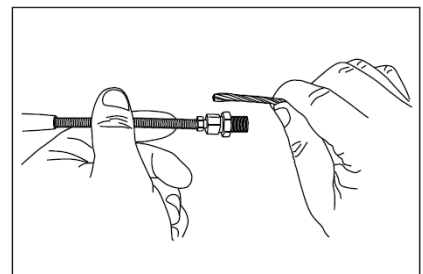
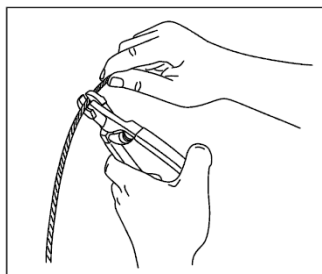
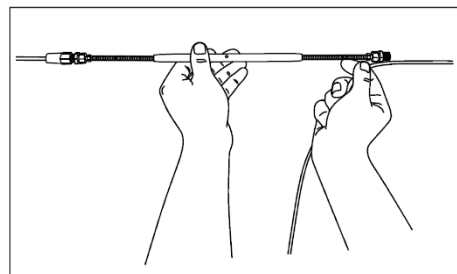

10. Disconnect the long screw from the turnbuckle and connect the opposite side of the cable to the long screw as described above (steps 3-6).

Note: Do not forget to insert the cone before inserting the jaw

11. Apply a small amount of the Anti-Seize lubricant to the long screws and spread it to cover the entire thread. Connect the long screw to the turnbuckle body with a few turns and make sure the turnbuckle is in the fully extended position with the long screws open equally.

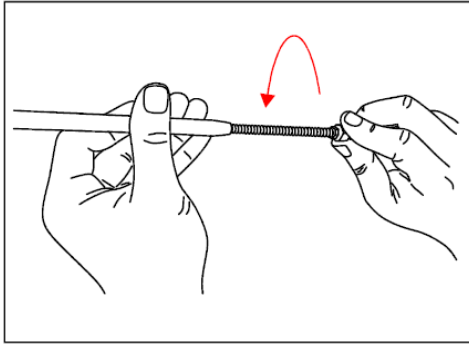

12. Hold the long screw ends with two wrenches/locking pliers to prevent them from turning. Tension the cable by turning the turnbuckle body using a wrench.

WARNING: Do not tension the cable by turning the long screws. It can result in uneven closure and unwinding of the cable.

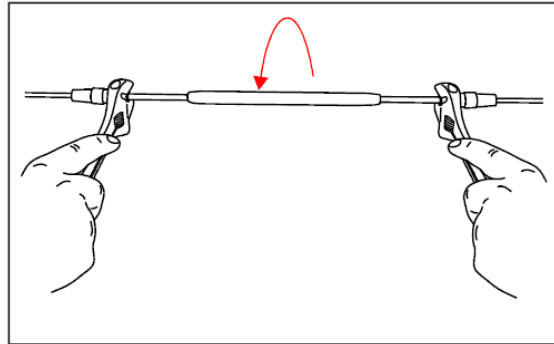

13. Tighten the small nut on the long thread towards the turnbuckle body to lock it.

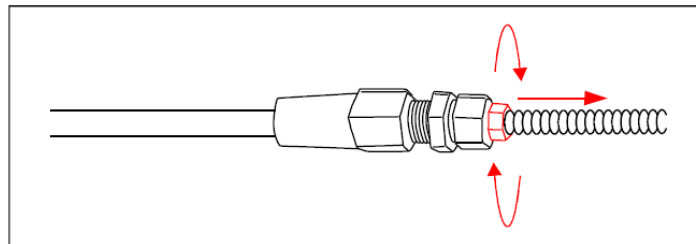

For longer canopies, an additional turnbuckle is supplied to be installed on the opposite side of the first turnbuckle to make the installation and tensioning of the cable easier.

14. When the cable is fully tensioned attach the safety clamps to each side of the cable on the turnbuckle side next to the eyelets. If for any reason the cable detaches from the turnbuckle the safety clamps help prevent the canopy from falling or slow its fall.

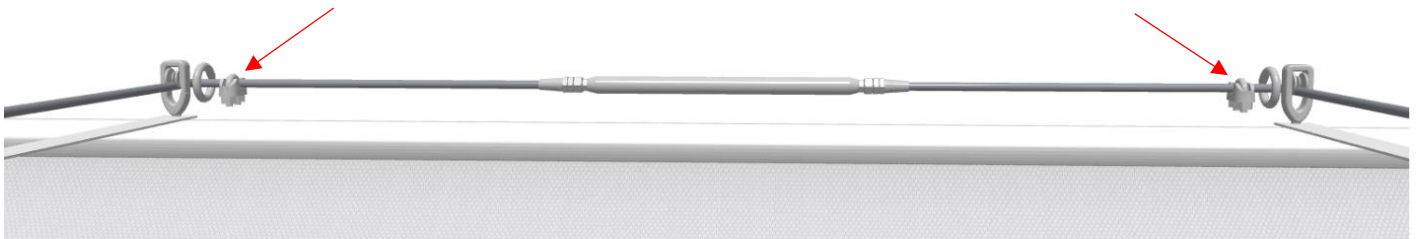

PART 3: Canopy Assembly

1. Confirm your measurements by holding the profile that you marked earlier against the cables and structure. Center it and mark the contact points with the cable a second time.

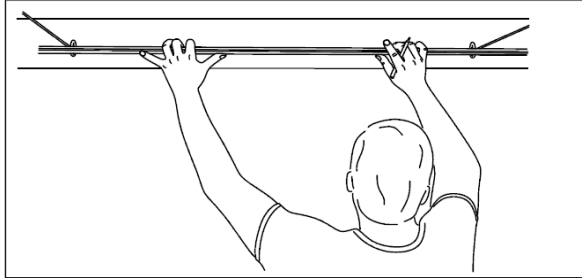

2. Place the profiles back to back with the triangular channel on the top. Align the ends with a straight edge and mark the location of the cable on to the remaining profiles.

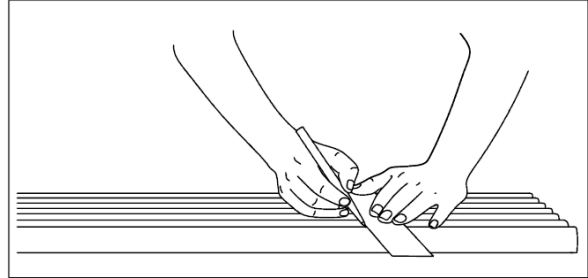

3. The cable connectors are comprised of two parts - the base that slides into the upper channel of the profile and the clip, which screws onto the base. Insert three bases for the first and last profile and two bases for the remaining profiles.

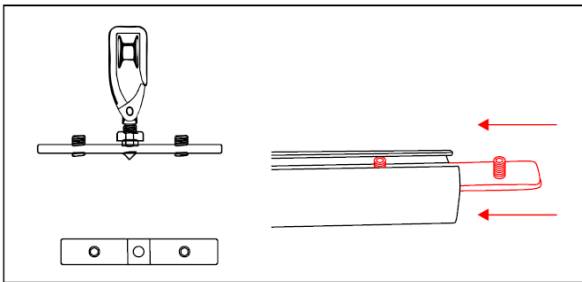

4. Align the middle hole of the bases with the markings made on the profile and tighten the side screws to secure the base inside the profile. Don't secure the third base in the middle of the first and last profile.

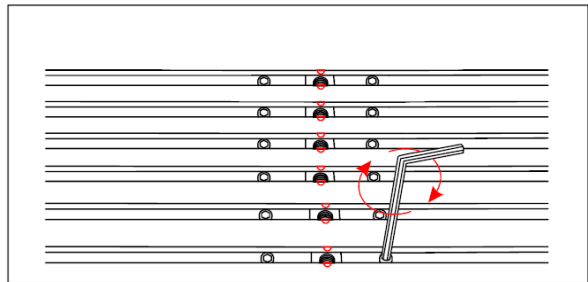

5. Loosen the end cap's screw and insert one into each profile (one side only). Tighten the screw to secure the end caps in place.

6. Place the panels on a flat surface or table then insert the first panel into the 2nd opening of the first profile (2) and 1st opening of the next profile (1) then install the endcaps.

Tip: You can place two panels back to back and insert them into the profile the same time.

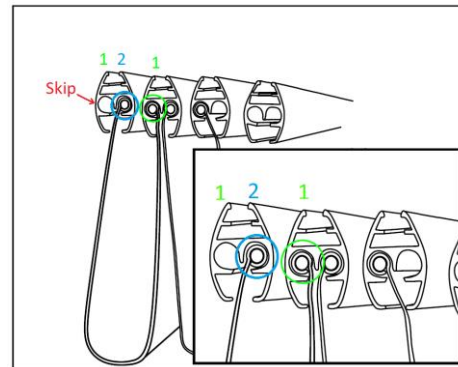
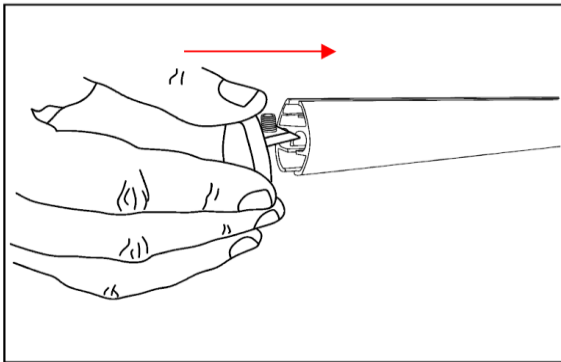

The outer opening of the first and last profiles should be empty. It is reserved for vertical panels (if ordered) or to make the canopy longer.

PART 4: Limit Tape and Clip Installation

The use of control tape is mandatory. It improves the canopy's look and uniformity and prevents the panels from hitting the cables by wind which can damage them. You can set the bellowing or flatness of the canopy as you like as well as control the bellowing of each panel independently.

Method 1. Based on Cable Length.

1. Measure the length of the installed cable from eye to eye in inches and divide it by the number of panels.
Example: Cable length 132"/6 (panels) = 22"
2. Mark the tape every 22"

Method 2. Your Desired Bellowing.

1. Separate the first and second profiles of the assembled canopy and open the first panel to the desired amount of bellowing.
2. Measure the distance of the profiles from center of the first to center of the second profile. Mark your tape based on this measurement.

3. The dots in the control tape are approximately 1 inch apart so you can count 22 dots then fold the tape from second marking to measure and mark the rest of tape.

4. Use a sharp tool to puncture the marked locations on the control tape. You can also use the clips which have a sharp end for this purpose.

Tip: For a more accurate measurement use a measuring tape instead of relying on the dots.

Tip: Fold under the ends of the tape and puncture twice for a clean finish at the ends.

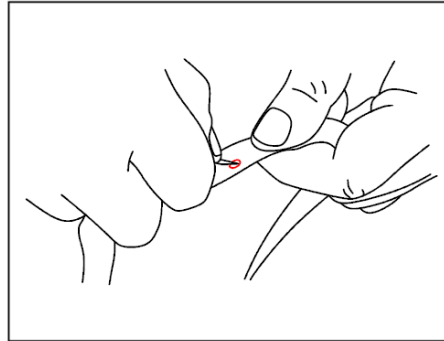
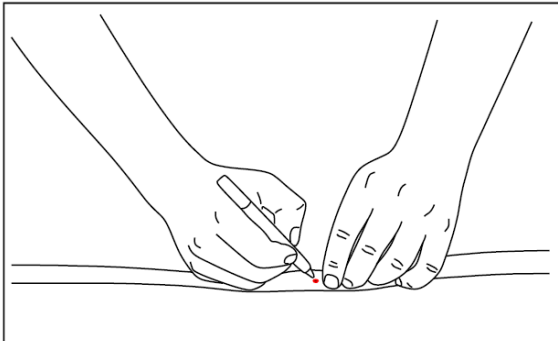

5. Insert the wheeled clips (H) into the tape and screw them onto the bases previously installed on the profiles. Make sure the tape is not twisted.

6. Tighten the wheeled clip so its gate points toward the end of the profile on the near side. Don't overtighten the clips. They should be able to turn slightly.

7. Install the middle clip (G) on the first and last profile. Do not tighten them so that the middle clip can move freely

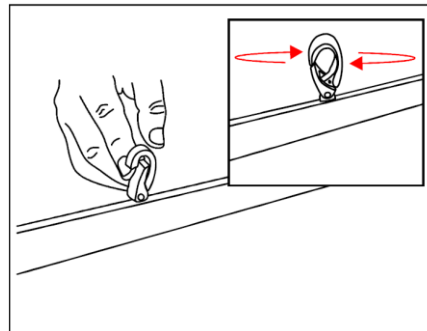

8. Clip the canopy to the wire by lifting each profile from one end and pressing the clip's gate against the cable.

9. Move the installed canopy to each end and select the desired position for the middle clip so it can easily attach to the crossing cables on either side. Tighten the clip and attach it to crossing cable behind and in front of the to lock it in place.

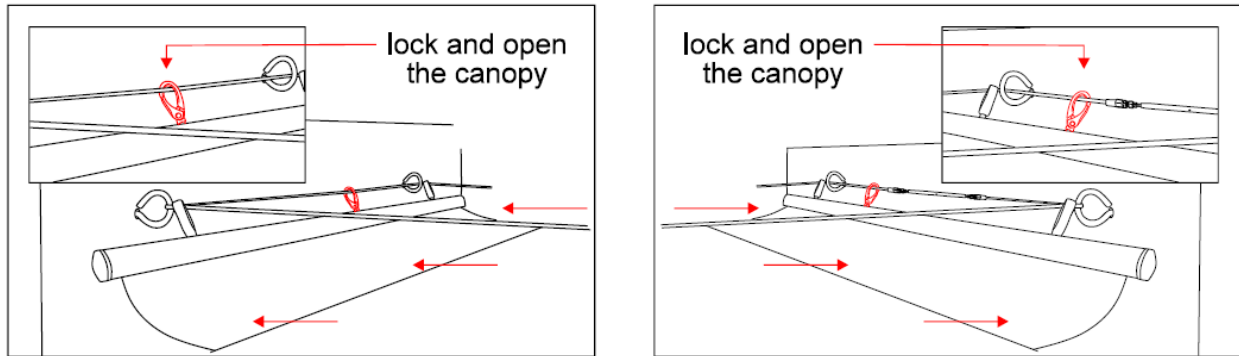

If you have ordered an optional closing system (the Magnetic Latch or the Pulley System) skip this step and refer to the installation manual for that item.

10. Use the remaining tape to make a pull handle. Cut the tape to the desired length, fold it over and insert the middle clip's screw into the tape. Then screw the clip to the middle base.

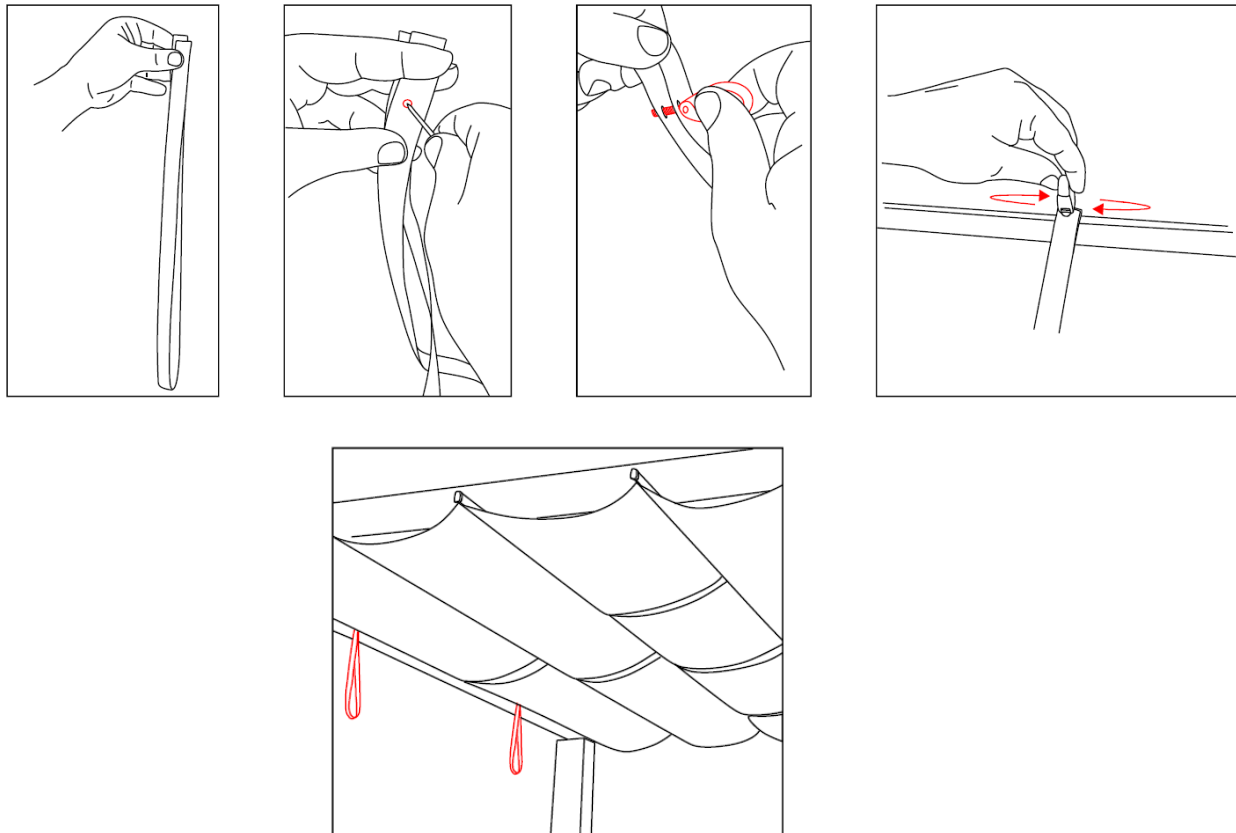

Installation instructions for different turnbuckles

If your turnbuckle comes with a brass ring place it over the cable making sure it protrudes 3/16" (5 mm) from the ring. Then Push all the parts firmly into the back of the cone.



Installation Manual for Jaw-Jaw Turnbuckle

After installing the eye screws to the structure and threading the cable continue here

1. Open the turnbuckle as much as possible on both sides.
2. Attach the cable as shown to one end of the turnbuckle.
 - a. The live portion of the cable is where it continues towards the eye (longer portion).
 - b. Attach the two clips one at a time with the one closest to the turnbuckle first
 - c. Make sure the live cable is close to the nut part of the clip as shown below
 - d. Tighten the clip's nuts to secure it to the cable.
 - e. Repeat with the second clip and cut the excess cable from the dead end.
3. Thread the cable to the opposite turnbuckle eye and pull it tight.
4. Attach the clips as described in step 2.
5. Turn the middle cylinder-nut of the turnbuckle to tension the cable as needed.

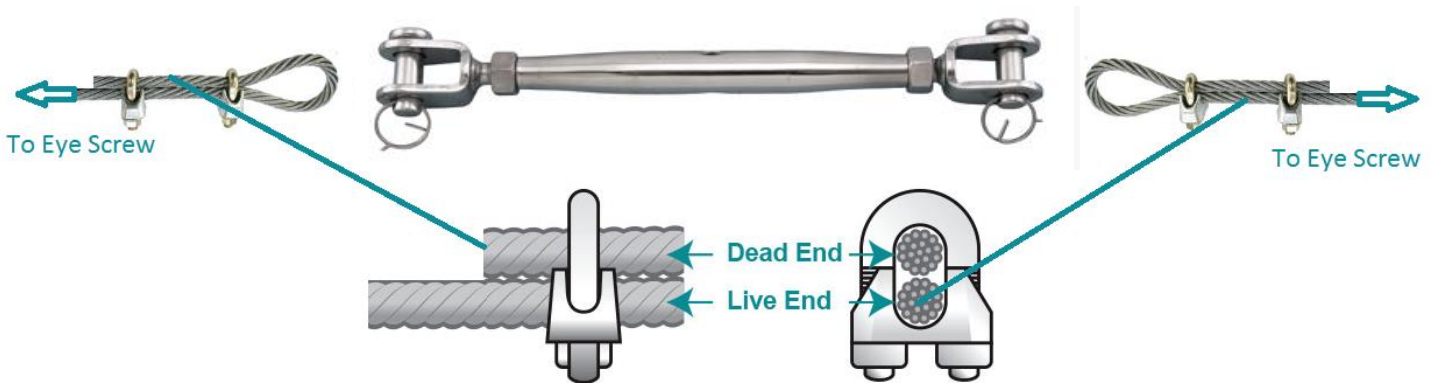

The correct installation method

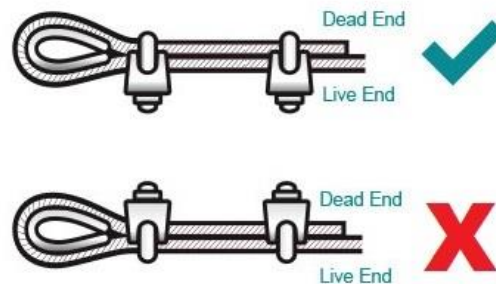

Infinity Canopy Final Look

